

BREEZE • HOT WAVE SERIES DOMESTIC INTEGRATED HEAT PUMP WATER HEATER
Installation and Operation Instructions

116-06-10-00239

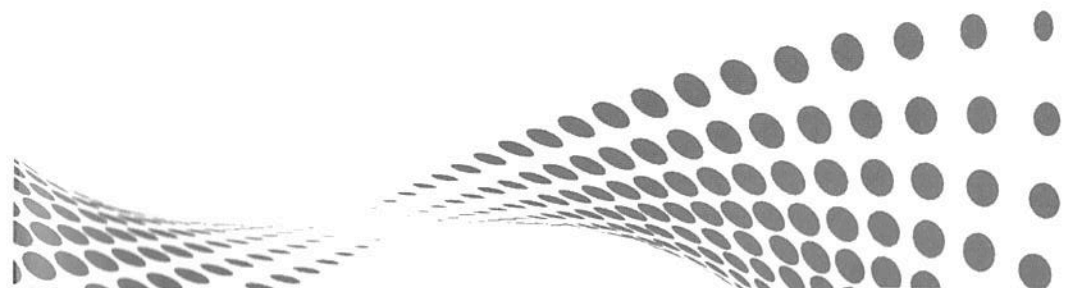

Content

I. Foreword	1
II. Operation Instruction	2
III. Maintenance and Trouble Shootings	5
IV. Technical Parameters	9
V. Installation	11
VI. Circuit Specification and Wiring Diagram	13
VII. Wi-Fi Function	16

I. Foreword

Please read the instruction carefully before install the unit, or we do not take any responsibility for the loss, please take care of it for future reference (If updated, please refer to the latest version).

Safety warning

It may cause injures for people or damages for units if do not operate as following



Heat pump water heater must be installed by Professionals.



The installation or maintenance of the unit must ensure that the ground wire is grounded safely and reliably, and live operation is strictly prohibited.



Must use 220V-240V/50Hz individual power supply.



Do not use mobile socket, damaged power cord and socket.



Do not power up until the tank is filled with water.



Do not put the inflammable and explosive material near the unit.



Do not repair, maintain, dismantle or transform the unit without permission .



Do not touch the plug with wet hands.



Do not put your hands or anything s close to the air outlet and blades.



In case of unit abnormality, please cut off the power supply immediately and contact our personnel for handling .

Safety notice

It may cause injures for people or poor performance of the unit if do not operate as following



Please cut off the power supply and drain the water from the heat pump if it is not used for a long time.



Please turn the water temperature into 38-42°C appropriately when operating the unit.



Do not drink the water in the heat pump directly.



The children must bath under the guidance of adult.



The water inlet and outlet pipes of the unit must be equipped with removable filters.



To get better energy saving effect, the unit should be installed in a good air-flowing place .

Do not cut off the power supply plugs to turn off the heat pump.

II. Operation Instruction

1. Panel Sign Description

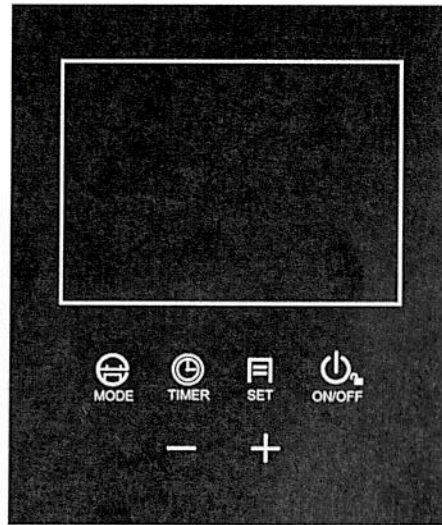

Sign	Name	Sign	Name	Sign	Name
	ON/OFF key		BATH sign		ERROR sign
	TIME key		CYCLIC VENTILATION sign		STANDBY TIMING key
	ELECTRIC HEATER key		ELECTRIC HEATER sign		SETTING key

	DEFROSTING sign		HEATING sign		LOCK sign
	UP key		DOWN key		

2. Operation Guidance Table

NO.	Item	Operation Method
1	Unlock	Touch both the UP key and the DOWN key for 5s to unlock.when unlocking, the LOCK sign is off.when locking, the LOCK sign is on.
2	ON/OFF	Touch the ON/OFF key, the unit will turn off if the panel is on and turn on if the panel is off.
3	Check Operation Parameters	The main interface displays the outlet water temperature by default, touch SETTING key, then touch the UP key and DOWN key to check each parameter.Short press the ON/OFF key or no operation in 10s, exit the query state.
4	Select Mode	Touch the SETTING key and STANDBY TIMING key for 5s to enter forced manual defrost mode.
5	Temperature Adjustment	Press the SETTING key 5S to enter the system parameter query, and query each parameter by combining the UP key and DOWN key. In the system query parameter state, press the SETTING key to set the parameter, and set each parameter by combining the UP key and DOWN key. The parameter serial number 0 is the default setting temperature of the water tank, and the parameter serial number 1 is the setting temperature of the heating return difference.
6	Time Adjustment	Touch the TIME key, hour flashes, touch the UP key and DOWN key to change the hour, touch the TIME key again, minute flashes, touch the UP key and DOWN key to change the minute. Touch the TIME key again to save the change and exit the clock setting.

7	Timing Adjustment	Touch the TIME key 5s, hour of Period 1 start flashes, touch the UP key and DOWN key to modify hours. Touch the TIME key again, minute flashes, touch the UP key and DOWN key to modify minutes. Continue to touch the TIME key to enter the time setting of Period 1 end, the operation is the same. Period 2 and period 3 are set in the same way. If the start and end time settings of the time period are the same, the time period is deemed to be canceled.
8	Manual turn on electric heater	In the state of power on or off, press the ELECTRIC HEATER key to enter or exit manual electric heating. When manual electric heater is on, the electric heater symbol lamp will be on.
9	Ventilation mode	Long press the ELECTRIC HEATER key to enter and exit the ventilation mode.
10	Restore defaults	In the shutdown state, long press the ELECTRIC HEATER key and SETTING key to restore factory setting parameters.
11	Set system parameter	In any state, press SETTING key for 5 seconds, enter the system parameter query interface, with UP key and DOWN key to query each parameter. In the system parameter query interface, press SETTING key to enter the parameter setting interface; with UP key and DOWN key to adjust parameter setting.

3. Operation parameter table

NO.	State Name	Name	Display Range	Reservations
A	Water tank inlet temp.	℃	-9~99℃	Error code P1
B	Water tank outlet temp.	℃	-9~99℃	Error code P2
C	Coil temp.	℃	-9~99℃	Error code P3
D	Suction temp.	℃	-9~99℃	Error code P4
E	Ambient temp.	℃	-9~99℃	Error code P5
F	EEV opening	℃	10~48	N*10

H	Solar water tank temp.	℃	0~125(C7)℃	Error code P6
I	Exhaust temp.	℃	0~125(C7)℃	Error code P7

III. Maintenance and Trouble Shootings

1. Maintenance

- External cleaning: To clean the heat pump unit, the power must be cut off, and a small amount of neutral detergent dipped in a wet cloth shall be used to gently wipe. Do not use gasoline or acid solution, alcohol, and finally dry with a dry cloth.
- Waterway cleaning: Empty and clean once every 3 months. Descaling materials: clean with organic acids such as formic acid, citric acid, acetic acid, etc.
- Evaporator cleaning: A hard nylon brush can be used to clean the fins of the evaporator. A vacuum cleaner must be used Before cleaning. If there is compressed air, a high-pressure air tube can be used to clean the fins of the heat exchanger.
- Note: If the solar coil is optional, if the ambient temperature is lower than 2℃, anti-freeze valves and pipelines shall be installed in the solar coil water channel and filled with anti-freeze liquid, such as glycerin-aqueous solution or ethylene glycol aqueous solution.
- Note: If the ambient temperature is lower than 2℃, please install circulating water pump on the customer's water side to avoid freezing of pipeline during use. When the machine is out of order, the water of the machine and the water side pipeline should be drained in time to avoid freezing of the pipeline. The installation of water pump is shown in "Installation".

Reference table of target concentration and target freezing point of unit antifreeze.

Glycerol		
Local lowest ambient temp. (℃)	Antifreeze mass target concentration percentage (kg/kg %)	Antifreeze target antifreeze point (℃)
0<T≤2	15	-3.2
-2<T≤0	20	-4.8
-4<T≤-2	25	-7.15
-6<T≤-4	30	-9.5
-8<T≤-6	35	-12.45
-12<T≤-8	40	-15.4
-17<T≤-12	45	-21.7
-25<T≤-17	50	-28
-29<T≤-25	55	-31.35
-31<T≤-29	60	-34.7

Glycol		
Local lowest ambient temp. (°C)	Antifreeze mass target concentration percentage (kg/kg %)	Antifreeze target antifreeze point (°C)
0<T≤2	10	-3.2
-2<T≤0	15	-5.4
-4<T≤-2	20	-7.8
-7<T≤-4	25	-10.7
-11<T≤-7	30	-14.1
-14<T≤-11	35	-17.9
-19<T≤-14	40	-22.3
-24<T≤-19	45	-27.5
-31<T≤-24	50	-33.8
-31<T≤-29	60	-34.7

Remarks: The mass percentage concentration C%=the mass of the solute/the mass of the solution. The example shows that the historically lowest ambient temperature in Shanghai, China is -12.1°C. Check the table above, and 45kg of glycerol should be added to the 100kg antifreeze mixture as antifreeze, or 100kg of antifreeze mixture needs to add 40kg of ethylene glycol as antifreeze.

2. Trouble shooting

Phenomenon	Reasons	Solutions
The unit doesn't work.	1.No power supply. 2.Power switch not on. 3.Power switch fuse blown. 4.The timing time is not up.	1.Please wait for the power supply. 2.Open up the power switch. 3.Replace fuse. 4.Please wait or cancel the timing settings.
The unit does not work when turns on.	1.Compressor protection interval not reached. 2.The unit water temperature does not reach the starting water temperature.	1.Please wait the protection time to end patiently. 2.It is normal phenomenon, wait for the starting water temperature.
The unit works normally, but the hot water temperature is low.	1.Improper temperature setting. 2.Excessive hot water consumption. 3.The air inlet or outlet of outdoor unit or indoor unit is blocked.	1.Set proper temperature. 2.Wait the hot water to warm up before using it. 3.Remove the obstruction from the air inlet or outlet.
The unit turns on automatically.	1.The timing time is up.	1.If you do not want to use it, please turn off the unit or cancel the timing settings.
Abnormal sound of the unit.	1.There is too much dust or obstruction on the air inlet of the unit evaporator, produce strong and weak sound of wind.	1.Remove the dust or obstructions from the unit evaporator.

	2.The Refrigerant flow may produce some noise when the unit turns on or turns off.	2.It is normal phenomenon.
	3.No power on, the unit rings like 'dada'.	3.It is normal phenomenon, reset of EEV.

3. Error Code

Some faults may happen in the unit if the panel displays the code as following during operating, please cut off the power switch immediately, and reclose the power switch after 30 seconds, you can continue using the unit if the code is not displayed, if the code is still displayed, please contact us for handling in time.

Error code	Protection/Error
	Standby
	Normal boot
P1	Water tank bottom temp. sensor failure
P2	Water tank top temp. sensor failure
P3	Coil temp. sensor failure
P4	Suction temp. sensor failure
P5	Ambient temp. sensor failure
P6	Solar temp. sensor failure
EC	Emergency switch failure
E1	High pressure protection
E2	Low pressure protection

4. System parameter

Code	Parameter	Range	Default	Note
0	Water tank temp.	10~75°C	60°C	Adjustable
1	Heating return difference temperature	2~15°C	5°C	Adjustable
2	Electric auxiliary heat start water tank temperature TS2	10~85°C	65°C	Adjustable
3	Delay time of the electric auxiliary heater t1	0~90s	1	Adjustable (Real time=setting value*5)
4	Electric auxiliary heater high temperature disinfection stop temp.	50~75°C	75	Adjustable
5	High temperature disinfection maintenance time t2	0~90min	30min	Adjustable
6	Heating defrosting cycle t3	30~90min	45min	Adjustable
7	Heating temperature point when start defrosting TS4	-30~0°C	0°C	Adjustable
8	Heating exit defrosting temperature TS5	2~30°C	15°C	Adjustable
9	Heating exit defrosting time T4	1~12min	8min	Adjustable
10	EEV adjust mode	0/1	1	0- Manual, 1- Automatic
11	Target superheat degree	-9~9°C	2°C	Adjustable
12	Manual adjust EEV steps	10~47	30	N*10

13	High temperature disinfection start time	0~23hours	0	In the state of continuous power, according to the set time once a week
14	Solar water pump or not	0:Yes/1:None	1	Adjustable
15	Temperature difference of solar water pump start	2~20	10℃	Adjustable
16	Disinfection days set	7~28	7	Adjustable
17	Expansion valve min.steps(Ambient temperature≥5℃)	8~15	10*10P	Adjustable
18	Expansion valve min.steps(Ambient temperature<5℃)	8~10	8*10P	Adjustable
19	Defrosting expansion valve set	2~45	40*10P	Adjustable
20	Expansion valve allowed exhaust temperature	70~120	100℃	Adjustable
21	Ambient temperature when allow defrosting	0~50	15℃	Adjustable
22	Temperature difference between ambient and coil when start defrosting	1~20	2℃	Adjustable
23	Exhaust high temperature protection value	50~110	105℃	Adjustable
24	Compressor running time when start electric heater	1~24hours	10hours	Adjustable

IV. Technical Parameters

1. Dimension

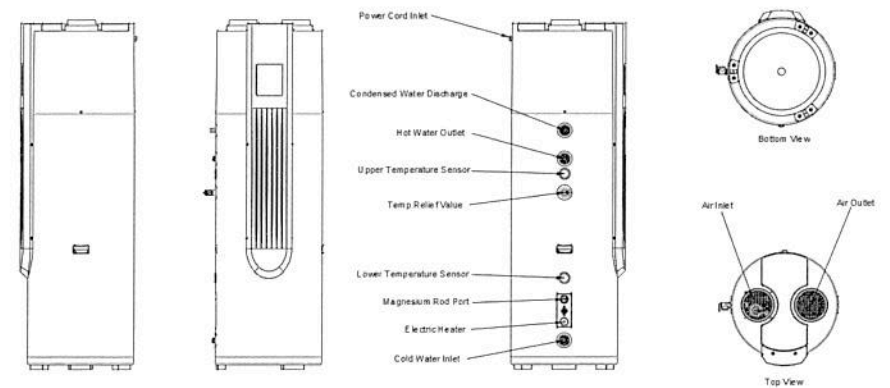
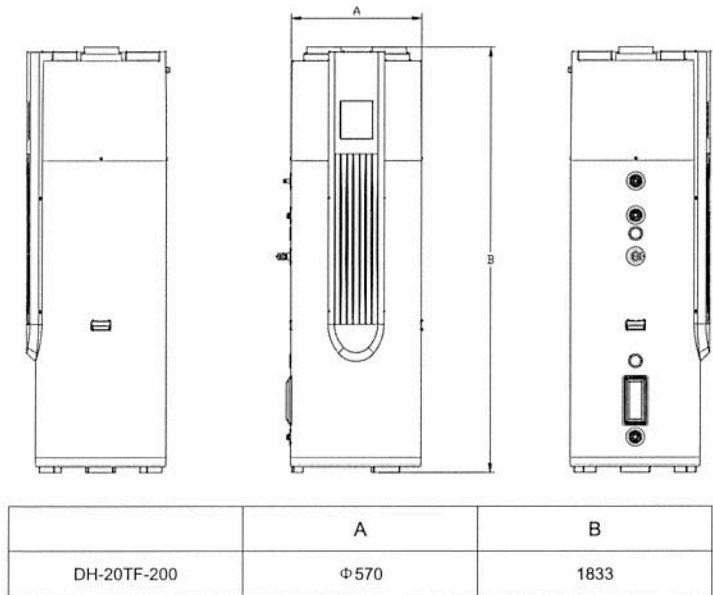

2. Parameter

Model:	DH-20TF-200
Power Supply	220-240V~/50Hz
Max.Outlet Water Temp. (°C)	75
Rated Heating Capacity (kW)	1.75
Consumen Power (kW)	0.488
COP	3.58
Max. Power Input (kW)	3.906
Max. Running Current (A)	18.1
Water Tank Volume (L)	200
Hot Water Volume (L/h)	33
Water Connection (inch)	G3/4"
Noise dB(A)	≤55
Operation Temp. Range (°C)	-7~43
Refrigerant	R134a
Net Weight (kg)	110
Net Dimensions(L*W*H) (mm)	Φ570×1833

The parameters in the table are nominal values according to the rated working condition specified in **EN 16147**, which will change with working condition;

The above parameters are subject to product nameplate, if changed due to the product upgrade, please kindly understand that we will not give prior notice.

V. Installation

1. Reservation Space

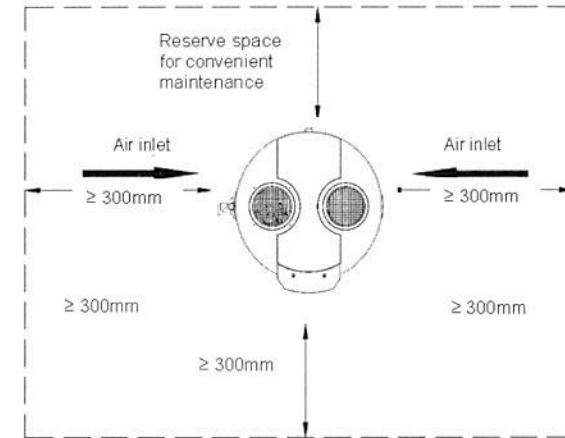

The minimum space required by the upward air outlet heat pump unit

2. Installation Schematic Diagram

WITH backwater control function

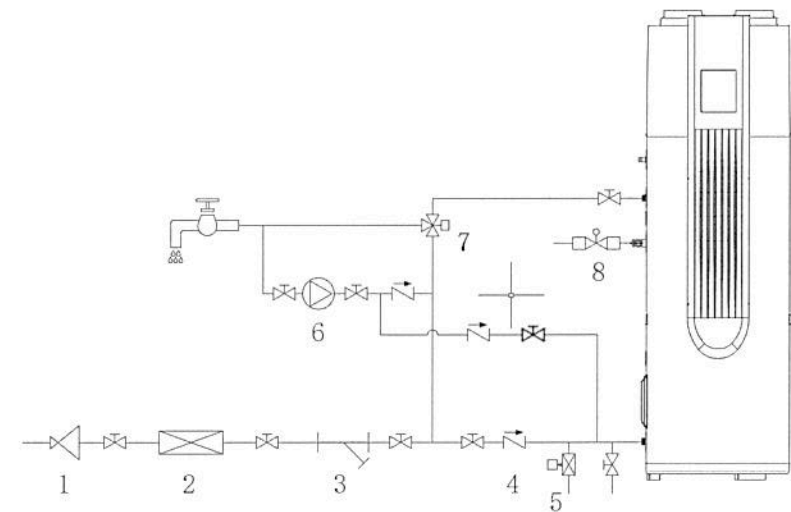

WITHOUT backwater control function

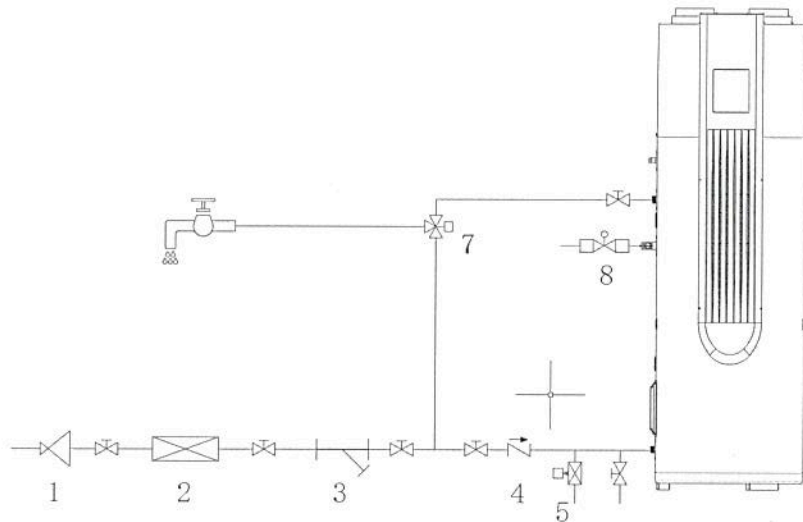

1	Pressure reducing valve	6	Circulating water pump
2	Water treating equipment	7	Water mixing valve
3	Y type filter	8	Temp.-Pressure relief valve
4	One-way valve		
5	Frost valve		

- The drain pipe of one-way pressure relief valve and condensate water drain pipe should be maintained in communication with the atmosphere.
- The one-way pressure relief valve operates periodically to remove calcium carbonate deposits and to certify that the installation is free of clogging.
- The drain pipe of the one-way pressure relief valve shall be installed in a continuous downward manner in a frost-free environment.
- The connection between the unit and the water pipe must be equipped with cut-off valves or removable loose connections.
- Water tank emptying operation: close the water replenishing valve, open the sewage gate valve, and connect the water in and out of the water tank (Watch out for burns!).
- For the area where the historical minimum ring temperature is lower than 2°C, the pipeline antifreeze valve should be installed.
- For cold areas, it is necessary to install the user-side circulating water pump according to the situation, so as to avoid icing of the user-side pipeline
- The condensate water outlet must be connected to the drain pipe. Prevent condensate water falling off along the unit, causing unit intake water and rust.

VI. Circuit Specification and Wiring Diagram

1. The installation work of circuit wiring must be operated refer to the wiring diagram on the unit and according to the requirements of national wiring specification by the professionals, and pay attention to the following points during use:

- The power line and grounding shall meet the relevant national regulations and requirements for safe power use. Make sure that the voltage is consistent with the nameplate, and whether the carrying capacity of power supply, wire and socket is suitable for the inlet power of the machine.
- Regulations of fuse tube: according to IEC, the rated current of fuse tube can be selected as 90% -100% of the rated maximum current of nameplate nominal value, and the maximum non fusing current of overload capacity is 150% of the rated maximum power current of nameplate.
- When the unit is installed outdoors, the power cord with plug shall not be used, and the power cord used shall not be lighter than the neoprene armored flexible cord (line 57 in IEC 60245). The wire diameter specification of power cord, air circuit breaker, leakage circuit breaker and load current comparison table.

Maximum current of heat pump units(A)	Wire cross section(mm ²)	Tripping current of air circuit breaker(A)	Leakage circuit breaker action current(mA)
<10	≥1.5	16	30
10~16	≥2.5	25	30
16~25	≥4.0	32	30
25~32	≥6.0	40	30

- When the power supply is connected, it must be equipped with full pole disconnecting device and leakage protection device that match the unit and have a contact opening distance of at least 3mm from the power supply. if the power cord is broken, it must be replaced by professionals from the manufacturer, its maintenance department or similar departments to avoid danger.
- After the power cord is installed and fixed firmly, pull the fixed power cord with a tension meter of 100N, and the power cord moving distance should be less than 2mm, otherwise, fix the power cord again, and the power cord wiring diagram:

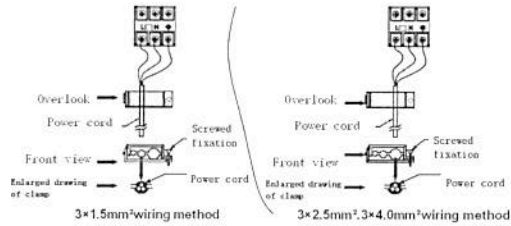

- When finishing the work, switch on the power supply after carefully checking.

2. Wiring Diagram

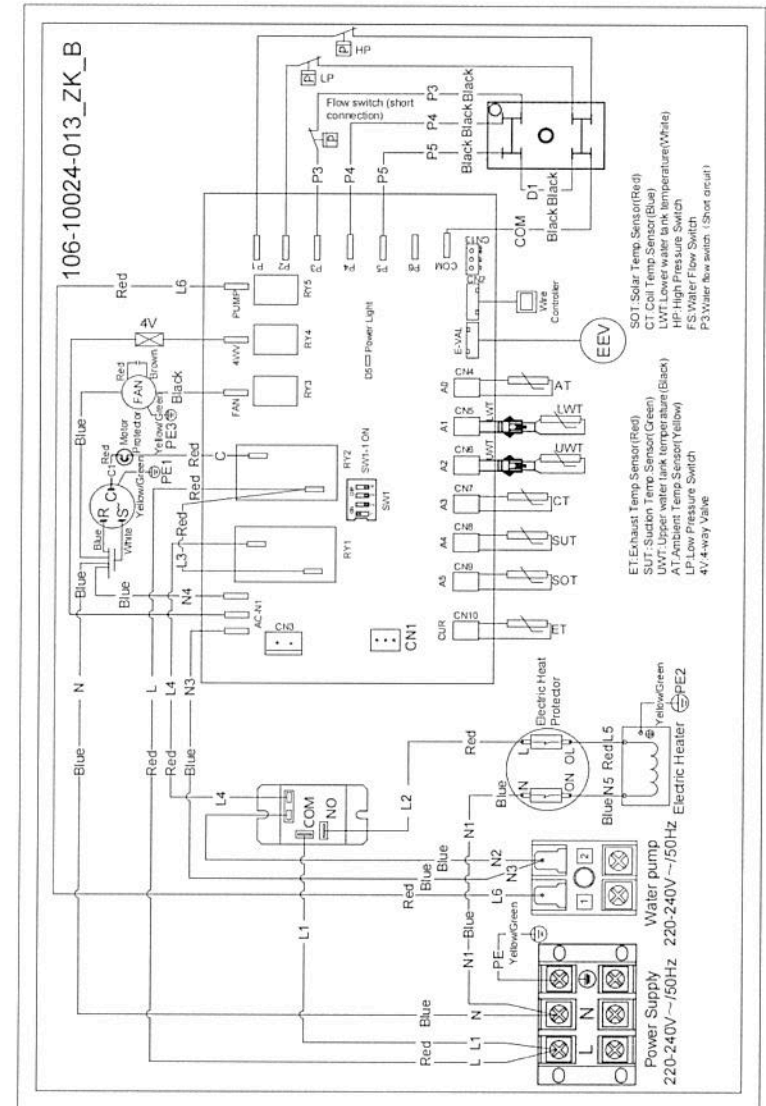

The connection methods between the units and power supply and the interconnection methods of each individual part should be according to the wiring diagram on the unit.

VII. Wi-Fi Function

1. Software Installation

- 1 Method 1: Search "Smart life" in your APP store ,install "".Click "GET" to install.



- 2 Method 2: Scan the QR code below.



For IOS and Android Users





2. Software Startup

After installation,click "" on your desktop to start up Smart Life.





3. Software Registration and Configuration

1. Registration

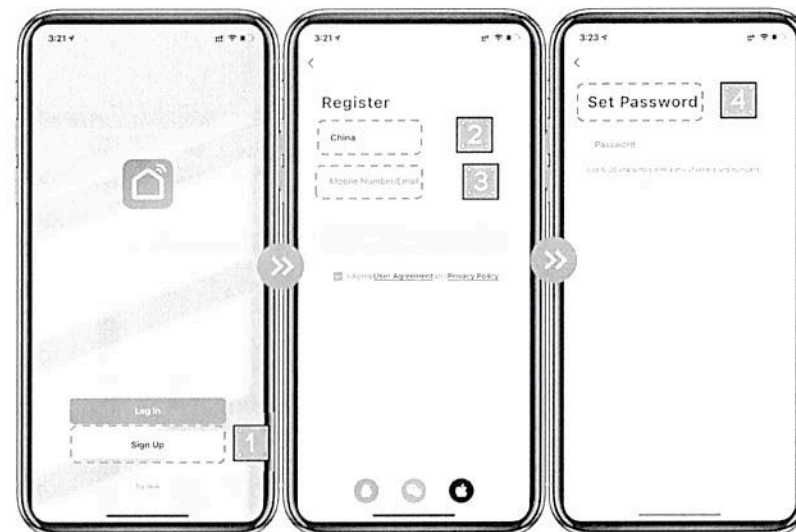
- 1 Users don't have account can click "Register" to create an account: Register  Enter your phone number  Get Verification Code  Enter Verification Code  Set Password;



- 2 After registration, you need to Create a Home:Create a Home  Set Home Name  Set Home Location  Add Rooms.

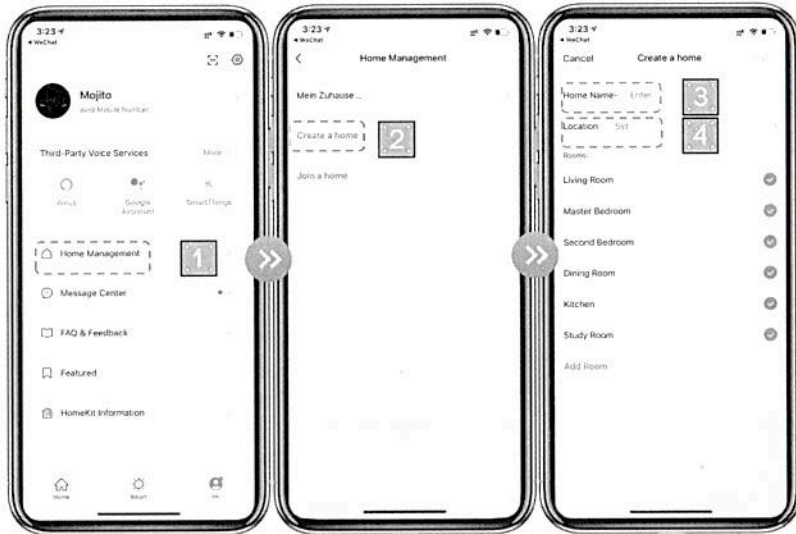

2. Account ID+ Password Login

1 Existing accounts can be logged in directly, in the following order.



2 If you forget your password you can choose to login with your verification code and select

"Forget Password": Enter your phone number → Get verification code .

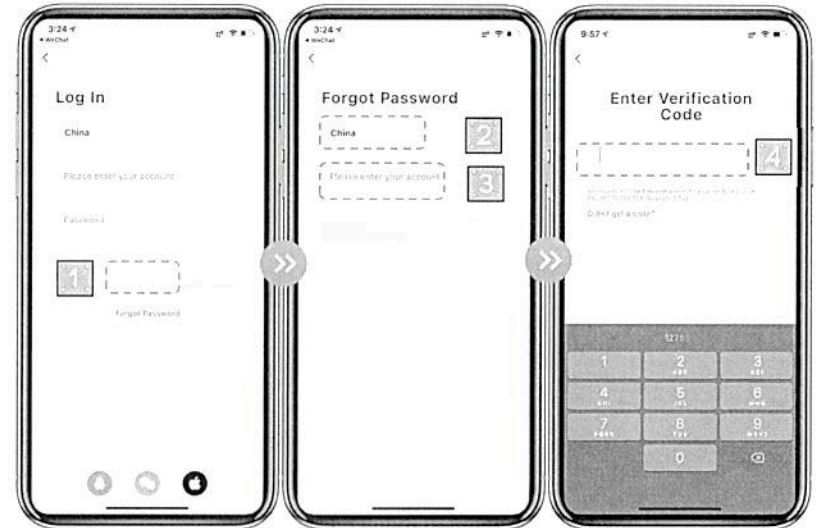

3 After creating a home or logged in, enter the main interface of APP.



Note:

Click "+" or "Add Device" to add devices.

3. Wi-Fi Module configuration steps:

Method 1

Step 1:

EZ Mode: When power is on, press and hold the "Y" and "▲" keys at the same time for 5s to enter the distribution network. The "🔒" icon will flash rapidly; if the Wi-Fi is connected successfully, the "🔒" icon will not appear.

Step 2:

Turn on the phone's Wi-Fi function and connect to the Wi-Fi hot-spot. The Wi-Fi hot-spot must be able to connect to the Internet normally;



Step 3:

Open the "smart life" APP, log in to the main interface, click on the top right corner "+" or "add equipment" of the interface, enter the equipment type selection, the "Large Home Appliances", select "Water Heater" equipment and add equipment into the interface.

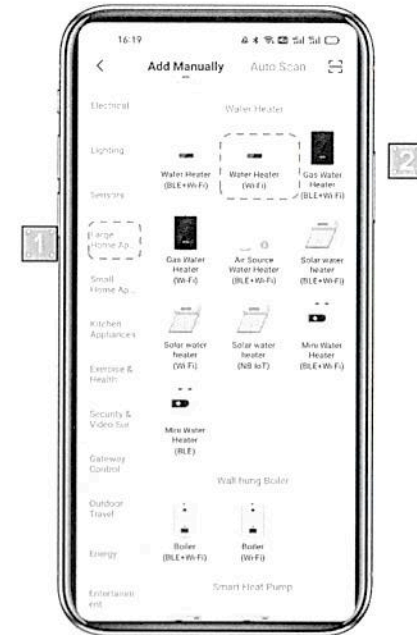

Step 4:

After selecting "Water Heater", enter the interface of "Add Equipment", and confirm that the wire controller has selected the EZ mode. After the indicator light under "🔒" flashes rapidly, click "Confirm indicator rapidly blink".

Enter the Wi-Fi connection interface, enter the Wi-Fi password of the mobile phone (it must be the same as the Wi-Fi of the mobile phone), click "Next", and then directly enter the connected status of the device.



Step 5: When "Scan devices", "Register on Cloud", "Initialize the device" are all completed, connect succeeds.



Method 2

Step 1

AP Mode: Press and hold the "🔄 + 🔌 + ▲" keys at the same time for 5s to enter the distribution network. The "🔒" icon will flash slowly..

Step 2&3

Same with EZ Mode above.

Step 4

After entering the add device interface, click "EZ Mode" in the upper right corner; Enter the AP mode to add the device interface, confirm that the AP mode has been selected, and click "Confirm indicator slowly blink".

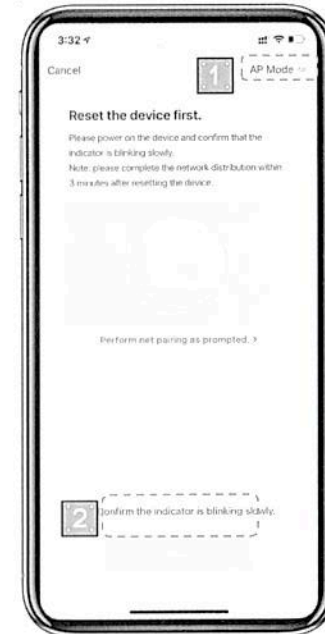

The interface of Wi-Fi connection will pop up, enter the Wi-Fi password of the mobile phone (it must be the same as the Wi-Fi of the mobile phone), click "Next", "Connect your mobile phone to the device's hot spot" will pop up, and click "Go to Connect";



Enter the mobile phone Wi-Fi connection interface, find the "SmartLife_XXXX" connection, and the APP will automatically enter the device connection status.



Step 5 : Same as EZ mode above.

Note: If the connection is failed, please enter the AP mode manually and reconnect according to the above steps.

4. Software Function Operation

- After the device is bound successfully, enter the operation interface of "Smart heat pump" (Device name, modifiable)
- In the main interface of "Smart Life", click "Smart heat pump" to enter the operation interface.

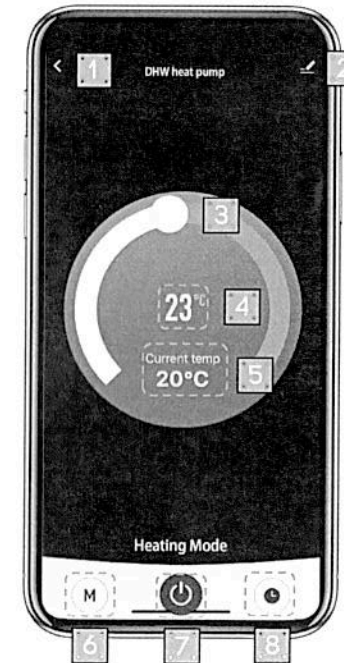

- 1 Back
- 2 More: You can change device name, select device installation location, check networking status, add Shared users, create device cluster, view device information, and more.
- 3 Setting temperature adjustment: The white circle slides counterclockwise to reduce the temperature, but clockwise to increase the temperature.
- 4 Target temperature
- 5 Current temperature
- 6 Mode switching: Click to select the mode to be switched.
- 7 ON/OFF
- 8 Timing: Click to add timing off/on time.

● **Modify device name**

Click in the following order to enter device details, and click "Device Name" to rename the

device.



● **Device sharing**

- ◆ To share a bound device, the user should do so in the following order.
- ◆ After successful sharing, the list will be added to show the person shared
- ◆ If you want to delete the account you shared to, cross the selected account to the left, and delete it.
- ◆ The user interface is as follows.



- ◆ Enter the account of the shared, click "Done", and the share success list shows the newly added account of the Shared.



- ◆ The interface of the person to be shared is as follows. The received shared device is displayed. Click it to operate and control the device.



● **Mode settings**

Click "M" on the main interface to switch modes, select what you need.



● **Timer setting**

1. Click "⊕" on the main interface to enter timer setting interface, as shown below, click to add timer.



2. After entering timer setting, swipe up/down to set timer, set up repeat weeks and on/off, then click "save" to save your settings as follows.

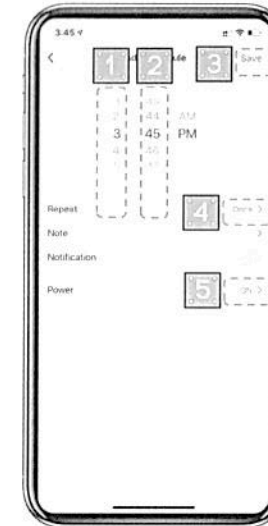

- 1 Hours
- 2 Minutes
- 3 Set the repetition
- 4 Set power ON/OFF
- 5 Save your modification

5. Device Removal

Click "🔧" on the top right corner of the main interface to enter the device details interface, and click "device removal" to enter EZ mode. Indicator light under "🔧" flashes rapidly for 3min, The network can be reconfigured within 3 minutes, and the network can be quit if it is not connected within 3 minutes. The specific operations are shown as follows.

