

RS SERIES

The RS burners series covers a firing range from 44 to 2290 kW, and it has been designed for use in low or medium temperature hot water boilers, hot air or steam boilers, diathermic oil boilers.

Operation is "two stage progressive"; the burners are fitted with a microprocessor-based burner safety control box which supplies indication of operation and diagnosis of fault cause.

The elevated performance of the fans and combustion head, guarantee flexibility of use and excellent working at all firing rates.

The exclusive design ensures reduced dimensions, simple use and maintenance. Optimisation of sound emissions is guaranteed by the special design of the air suction circuit and by incorporated sound proofing material. A wide range of accessories guarantees elevated working flexibility.

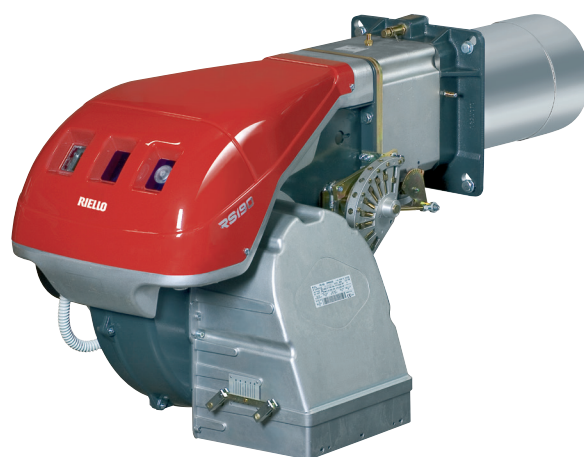

RS 34 MZ	45/125 ÷ 390 kW
RS 44 MZ	80/203 ÷ 550 kW
RS 50	115/290 ÷ 600 kW
RS 64 MZ	150/400 ÷ 850 kW
RS 70	192/465 ÷ 814 kW
RS 100	232/698 ÷ 1163 kW
RS 130	372/930 ÷ 1512 kW
RS 150	300/900 ÷ 1850 kW
RS 190	470/1279 ÷ 2290 kW

FIRING RATES

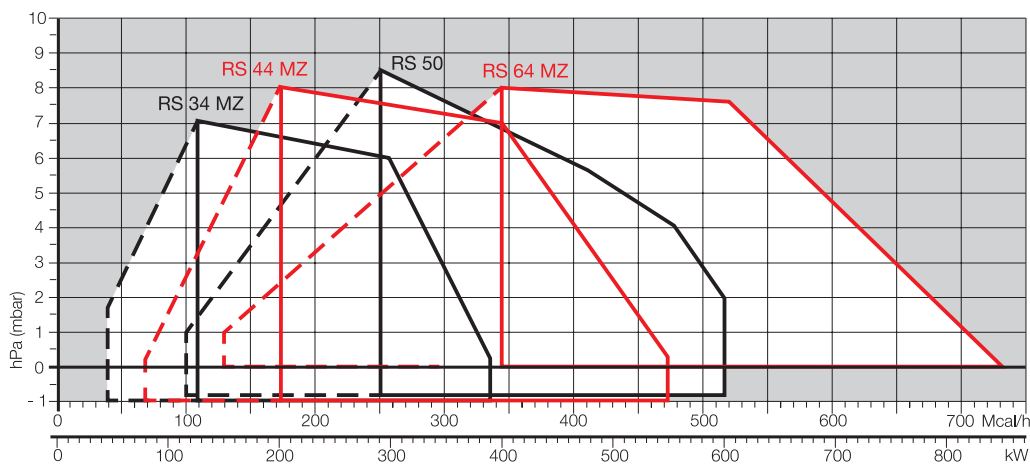

 Useful working field for choosing the burner

 1st stage operation range

Test conditions conforming to EN676
 Temperature: 20°C
 Pressure: 1013,5 mbar
 Altitude: 0 m a.s.l.

Two Stage Progressive Gas Burners

RS SERIES

FIRING RATES

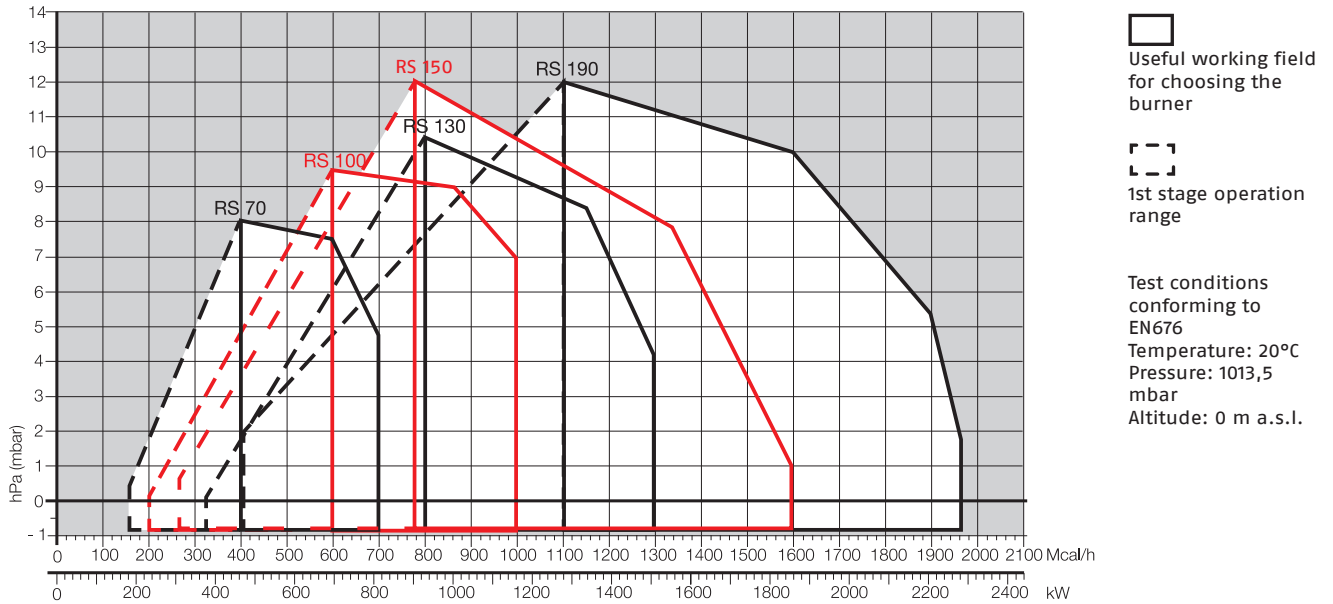

Overall dimensions (mm)

BURNER

RS 34 MZ - 44 MZ

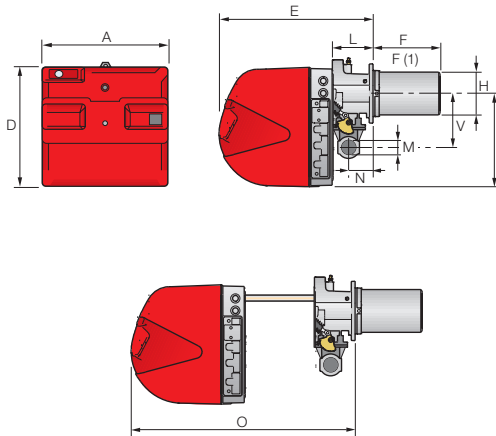

RS 50

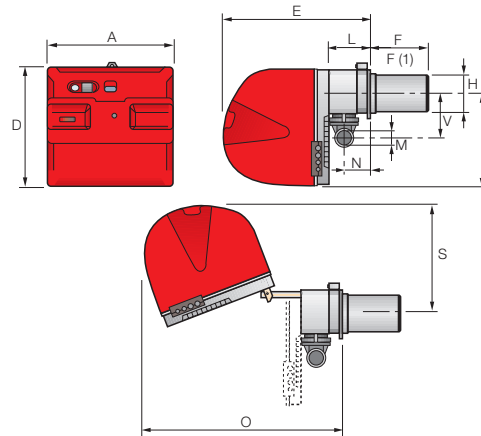

MODEL	A	D	E	F - F(1)	H	I	L	M	N	O	S	V
▶ RS 34 MZ	442	422	508	216 - 351	140	305	138	1 1/2	84	780	-	177
▶ RS 44 MZ	442	422	508	216 - 351	152	305	138	1 1/2	84	780	-	177
▶ RS 50	476	474	580	216 - 351	152	352	164	1 1/2	108	810	367	168

(1) dimension with extended head

RS 64 MZ

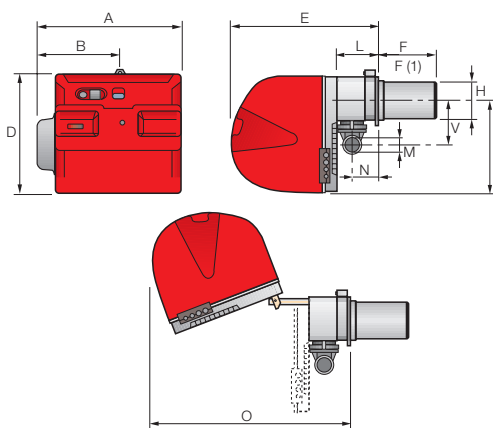

RS 70 - 100 - 130 - 150 - 190

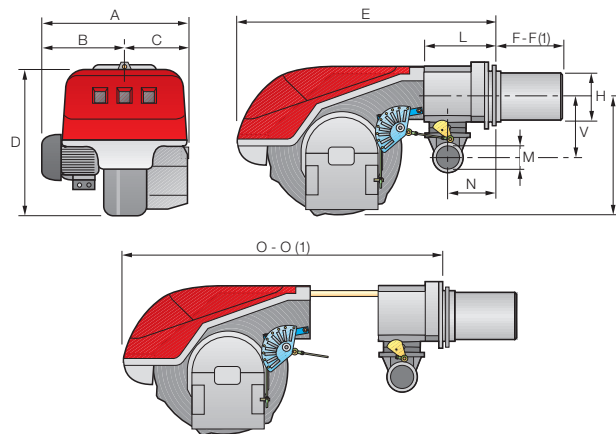

MODEL	A	B	C	D	E	F - F(1)	H	I	L	M	N	O - O(1)	V
▶ RS 64 MZ	533	300	-	490	640	250 - 385	179	352	222	2"	134	870 - -	221
▶ RS 70	511	296	215	555	840	250 - 385	179	430	214	2"	134	1161 - 1296	221
▶ RS 100	527	312	215	555	840	250 - 385	179	430	214	2"	134	1161 - 1296	221
▶ RS 130	553	338	215	555	840	280 - 415	189	430	214	2"	134	1161 - 1296	221
▶ RS 150	675	370	305	590	840	280 - 415	189	435	214	2"	134	1180 - 1315	221
▶ RS 190	681	366	315	555	872	370 - 520	222	430	246	2"	150	1328 - -	262

(1) dimension with extended head

Two Stage Progressive Gas Burners

RS SERIES

Overall dimensions (mm)

BURNER - BOILER MOUNTING FLANGE

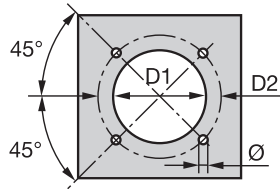

MODEL	D1	D2	Ø
▶ RS 34 MZ	160	224	M8
▶ RS 44 MZ	160	224	M8
▶ RS 50	160	224	M8
▶ RS 64 MZ	185	275-325	M12
▶ RS 70	185	275-325	M12
▶ RS 100	185	275-325	M12
▶ RS 130	195	275-325	M12
▶ RS 150	195	275-325	M12
▶ RS 190	230	325-368	M16

PACKAGING

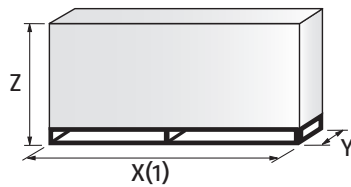

MODEL	X (1)	Y	Z	kg
▶ RS 34 MZ	1000	485	500	32
▶ RS 44 MZ	1000	485	500	33
▶ RS 50	1200	502	520	41
▶ RS 64 MZ	1200	580	520	42
▶ RS 70	1405	700	660	70
▶ RS 100	1405	700	660	73
▶ RS 130	1400	700	660	76
▶ RS 150	1400-1420	1000	660	110
▶ RS 190	1400-1420	1000	660	115

(1) dimension with standard and extended head

Specification

DESIGNATION OF SERIES

Series: R										
Fuel:		S	Natural Gas							
		SP	LPG							
		L	Light oil							
		LS	Light oil/Methane							
		N	Heavy oil							
Size										
Setting:		/1	Single stage							
		...	Two stage							
		/M	Modulating							
Emission:		...	Class 1 EN267 - EN676							
		MZ	Class 2 EN267 - EN676							
		BLU	Class 3 EN267 - EN676							
		MX	Class 1 EN267 Class 3 EN676							
Head length:		TC	standard head							
		TL	extended head							
Flame control system:		FS1	Standard (1 stop every 24 h)							
		FS2	Continuous working (1 stop every 72 h)							
Electrical supply to the system:										
		1/230/50	1/230V/50Hz							
		1/220-230/50-60	1/220-230V/50-60Hz							
		3/230/50	3/230V/50Hz							
		3/400/50	3N/400V/50Hz							
		3/230-400/50	3/230V/50Hz - 3N/400V/50Hz							
		3/220/60	3/220V/60Hz							
		3/380/60	3N/380V/60Hz							
		3/220-380/60	3/220V/60Hz - 3N/380V/60Hz							
		3/220-400/50-60	3/220-230V/50-60Hz 3/380-400V/50-60Hz							
Auxiliary voltage:		230/50-60	230V/50-60Hz							
		220-230/50-60	220-230V/50-60Hz							
		110/50-60	110V/50-60Hz							
ID: Differential switch										
R	S	130			TC	FS1	3/230-400/50	230/50-60		
BASIC DESIGNATION										
EXTENDED DESIGNATION										

Two Stage Progressive Gas Burners

RS SERIES

Specification

STATE OF SUPPLY

RS 34 MZ – 44 MZ models

Monoblock forced draught gas burner with two stage operation, fully automatic, made up of:

- Air suction circuit with sound proofing material
- High performance fan with straight blades
- Air damper for air flow setting and butterfly valve for regulating fuel output on 1st and 2nd stage controlled by a servomotor with variable cam
- Starting motor at 2800 rpm, single-phase / 220-230V / 50-60Hz or three-phase / 380-400V / 50-60Hz
- Combustion head, that can be set on the basis of required output, fitted with:
 - stainless steel end cone, resistant to corrosion and high temperatures
 - ignition electrodes
 - ionisation probe
 - gas distributor
 - flame stability disk
- Exclusive patented HCS (Housing Cooling System) with high thermal insulation and air circulation with continuous air volume refresh for an active cooling system and avoid heat transfer to the electrical component housing
- Minimum air pressure switch stops the burner in case of insufficient air quantity at the combustion head
- Microprocessor-based burner safety control box, with diagnostic functions
- Plug and socket for electrical connections accessible from the external of the cover
- Burner on/off selection switch
- 1st – 2nd stage manual switch
- Flame inspection window
- Slide bars for easier installation and maintenance
- Protection filter against radio interference
- IP X0D (IP 40) electric protection level.

Standard equipment

- 1 gas train flange
- 1 flange gasket
- 4 screws for fixing the flange
- 1 thermal screen
- 4 screws for fixing the burner flange to the boiler
- 3 plugs for electrical connection (RS 34 – 44 MZ single-phase)
- 4 plugs for electrical connection (RS 44 MZ three-phase)
- Instruction handbook for installation, use and maintenance
- Spare parts catalogue.

RS SERIES

Specification

STATE OF SUPPLY

RS 50 - 64 MZ - 70 - 100 - 130 - 150 - 190 models

Monoblock forced draught gas burner with two stage operation, fully automatic, made up of:

- Air suction circuit lined with sound-proofing material
- Fan with reverse curve blades (RS 50 - 70 - 100 - 130 models) or straight blades (RS 64 MZ - 150-190 models)
- Air damper for air flow setting and butterfly valve for regulating fuel output on 1st and 2nd stage controlled by a servomotor with variable cam
- Starting motor at 2800 rpm, three-phase 400V with neutral, 50Hz
- Combustion head, that can be set on the basis of required output, fitted with:
 - stainless steel end cone, resistant to corrosion and high temperatures
 - ignition electrodes
 - ionisation probe
 - gas distributor
 - flame stability disk
- Minimum air pressure switch stops the burner in case of insufficient air quantity at the combustion head
- Microprocessor-based burner safety control box, with diagnostic functions
- Plug and socket for electrical connections (RS 50-64 models)
- Burner on/off selection switch
- 1st - 2nd stage manual switch
- Flame inspection window
- Slide bars for easier installation and maintenance
- Protection filter against radio interference
- IP 44 electric protection level.

Standard equipment

- 1 gas train flange
- 1 flange gasket
- 4 screws for fixing the flange
- 1 thermal screen
- 4 screws for fixing the burner flange to the boiler
- Wiring loom fittings for the electrical connection (RS 50-64)
- 2 slide bar extensions (for extended head models and RS 150-190 model)
- Instruction handbook for installation, use and maintenance
- Spare parts catalogue.

Two Stage Progressive Gas Burners

RS SERIES

Available models

Burners

CODE	MODEL					HEAT OUTPUT NATURAL GAS		TOTAL ELECTRICAL POWER (kW)	CERTIFICATION	NOTE
						(kW)	(Nm ³ /h)			
3789010	RS 34 MZ	TC	FS1	1/230/50-60	230/50-60	44/130-390	4,5/13-39	0,6	CE 0085BR0381	(1)
3789011	RS 34 MZ	TL	FS1	1/230/50-60	230/50-60	44/130-390	4,5/13-39	0,6	CE 0085BR0381	(1)
20008266	RSP 34	TC	FS1	1/230/50-60	230/50-60	44/130-390	4,5/13-39	0,6	CE 0085BR0381	(1)
3789110	RS 44 MZ	TC	FS1	1/230/50-60	230/50-60	80/200-550	8/20-55	0,7	CE 0085BR0381	(1)
3789111	RS 44 MZ	TL	FS1	1/230/50-60	230/50-60	80/200-550	8/20-55	0,7	CE 0085BR0381	(1)
3789140	RS 44 MZ	TC	FS1	3/230-400/50-60	230/50-60	80/200-550	8/20-55	0,8	CE 0085BR0381	(1)
3789141	RS 44 MZ	TL	FS1	3/230-400/50-60	230/50-60	80/200-550	8/20-55	0,8	CE 0085BR0381	(1)
3784702	RS 50	TC	FS1	3/230-400/50	230/50-60	115/290-600	12/29-58	0,75	CE 0085AP0735	(1)
3784703	RS 50	TL	FS1	3/230-400/50	230/50-60	115/290-600	12/29-58	0,75	CE 0085AP0735	(1)
3784720	RS 50	TC	FS1	3/220-380/60	230/50-60	115/290-600	12/29-58	0,75	-	(1)
3784721	RS 50	TL	FS1	3/220-380/60	230/50-60	115/290-600	12/29-58	0,75	-	(1)
3789310	RS 64 MZ	TC	FS1	3/230-400/50	230/50-60	150/400-850	15/40-85	1,5	CE 0085BR0558	(1)
3789311	RS 64 MZ	TL	FS1	3/230-400/50	230/50-60	150/400-850	15/40-85	1,5	CE 0085BR0558	(1)
3789380	RS 64 MZ	TC	FS1	3/220-380/60	230/50-60	150/400-850	15/40-85	1,5	-	(1)
3789381	RS 64 MZ	TL	FS1	3/220-380/60	230/50-60	150/400-850	15/40-85	1,5	-	(1)
3785102	RS 70	TC	FS1	3/230-400/50	230/50-60	192/465-814	19/46,5-81	1,4	CE 0085AP0944	(2)
3785103	RS 70	TL	FS1	3/230-400/50	230/50-60	192/465-814	19/46,5-81	1,4	CE 0085AP0944	(2)
3785104	RS 70	TC	FS1	3/230-400/50	230/50-60	192/465-814	19/46,5-81	1,4	CE 0085AP0944	(1) (2)
3785105	RS 70	TL	FS1	3/230-400/50	230/50-60	192/465-814	19/46,5-81	1,4	CE 0085AP0944	(1) (2)
3785120	RS 70	TC	FS1	3/220-380/60	230/50-60	192/465-814	19/46,5-81	1,4	-	(2)
3785121	RS 70	TL	FS1	3/220-380/60	230/50-60	192/465-814	19/46,5-81	1,4	-	(2)
3785302	RS 100	TC	FS1	3/230-400/50	230/50-60	232/698-1163	23/70-116	1,8	CE 0085AP0945	(2)
3785303	RS 100	TL	FS1	3/230-400/50	230/50-60	232/698-1163	23/70-116	1,8	CE 0085AP0945	(2)
3785304	RS 100	TC	FS1	3/230-400/50	230/50-60	232/698-1163	23/70-116	1,8	CE 0085AP0945	(1) (2)
3785305	RS 100	TL	FS1	3/230-400/50	230/50-60	232/698-1163	23/70-116	1,8	CE 0085AP0945	(1) (2)
3785320	RS 100	TC	FS1	3/220-380/60	230/50-60	232/698-1163	23/70-116	1,8	-	(2)
3785321	RS 100	TL	FS1	3/220-380/60	230/50-60	232/698-1163	23/70-116	1,8	-	(2)
3785502	RS 130	TC	FS1	3/230-400/50	230/50-60	372/930-1512	37/93-151	2,6	CE 0085AP0946	(2)
3785503	RS 130	TL	FS1	3/230-400/50	230/50-60	372/930-1512	37/93-151	2,6	CE 0085AP0946	(2)
3785504	RS 130	TC	FS1	3/230-400/50	230/50-60	372/930-1512	37/93-151	2,6	CE 0085AP0946	(1) (2)
3785505	RS 130	TL	FS1	3/230-400/50	230/50-60	372/930-1512	37/93-151	2,6	CE 0085AP0946	(1) (2)
3785520	RS 130	TC	FS1	3/220-380/60	230/50-60	372/930-1512	37/93-151	2,6	-	(2)
3785521	RS 130	TL	FS1	3/220-380/60	230/50-60	372/930-1512	37/93-151	2,6	-	(2)
20044636	RS 150	TC	FS1	3/400/50	230/50-60	300/900÷1850	30/90÷185	3,5	in progress	(2)
20044637	RS 150	TL	FS1	3/400/50	230/50-60	300/900÷1850	30/90÷185	3,5	in progress	(2)
20051309	RS 150	TC	FS1	3/230/50	230/50-60	300/900÷1850	30/90÷185	3,5	in progress	(2)
20051314	RS 150	TL	FS1	3/230/50	230/50-60	300/900÷1850	30/90÷185	3,5	in progress	(2)
3785813	RS 190	TC	FS1	3/400/50	230/50-60	470/1279-2290	47/128-229	5,5	CE 0085AT0042	(2)
20030087	RS 190	TL	FS1	3/400/50	230/50-60	470/1279-2290	47/128-229	5,5	CE 0085AT0042	(2)
20011698	RS 190	TC	FS1	3/230/50	230/50-60	470/1279-2290	47/128-229	5,5	CE 0085AT0042	(2)
3785814	RS 190	TC	FS1	3/400/50	230/50-60	470/1279-2290	47/128-229	5,5	CE 0085AT0042	(1) (2)
20011705	RS 190	TC	FS1	3/230/50	230/50-60	470/1279-2290	47/128-229	5,5	CE 0085AT0042	(1) (2)
3785820	RS 190	TC	FS1	3/380/60	230/50-60	470/1279-2290	47/128-229	5,5	-	(2)
20011699	RS 190	TC	FS1	3/220/60	220/60	470/1279-2290	47/128-229	5,5	-	(2)

Natural Gas, net calorific value: 10 kWh/Nm³ - Density at 20°C: 0,71 kg/Nm³

The burners of RS series are in according to 2009/142 - 2004/108 - 2006/95 - 2006/42 EC Directive and EN 676 Norm.

(1) With plug and socket. (2) With terminal board.

RS SERIES

Available models

Gas Trains

CODE	GAS TRAIN			VPS CODE	ADAPTER CODE									
	MODEL	Ø	C.T.		RS 34	RS 44-50	RS 64	RS 70	RS 100	RS 130	RS 150	RS 190		
3970500*	MB 405/1 - RT 20	Rp 3/4"	-	3010123	3000824			●	●	●	●	●	●	
3970553*	MB 407/1 - RT 20	Rp 3/4"	-	3010123				●	●	●	●	●	●	●
3970599*	MB 407/1 - RT 52	Rp 3/4"	-	3010123				●	●	●	●	●	●	●
3970229*	MB 407/1 - RSM 20	Rp 3/4"	-	3010123				●	●	●	●	●	●	●
3970258*	MB 410/1 - RT 52	Rp 1" 1/4	-	3010123	3010124			●	●	●	●	●		
3970554*	MB 410/1 - RT 20	Rp 3/4"	-	3010123	3000824			●	●	●	●	●		
3970600*	MB 410/1 - RT 52	Rp 3/4"	-	3010123				3000824 +	●	●	●	●	●	
3970230*	MB 410/1 - RSM 20	Rp 3/4"	-	3010123				3000843	●	●	●	●	●	
3970256*	MB 412/1 - RT 52	Rp 1" 1/2	-	3010123	-	-								
3970144*	MB 412/1 - RT 20	Rp 1" 1/2	-	3010123	-	-								
3970197**	MB 412/1 CT RT 20	Rp 1" 1/2	◆	-	-	-								
3970231*	MB 412/1 - RSM 20	Rp 1" 1/2	-	3010123	-	-								
3970180*	MB 415/1 - RT 30	Rp 1" 1/2	-	3010123	-	-			3000843					
3970198**	MB 415/1 CT RT 30	Rp 1" 1/2	◆	-	-	-								
3970250*	MB 415/1 - RT 52	Rp 1" 1/2	-	3010123	-	-								
3970253**	MB 415/1 CT RT 52	Rp 1" 1/2	◆	-	-	-								
3970232*	MB 415/1 - RSM 30	Rp 1" 1/2	-	3010123	-	-								
3970181*	MB 420/1 - RT 30	Rp 2"	-	3010123	3000822			-	-	-	-	-	-	
3970182**	MB 420/1 CT RT 30	Rp 2"	◆	-				-	-	-	-	-	-	-
3970257*	MB 420/1 - RT 52	Rp 2"	-	3010123				-	-	-	-	-	-	-
3970252**	MB 420/1 CT RT 52	Rp 2"	◆	-				-	-	-	-	-	-	-
3970233*	MB 420/1 - RSM 30	Rp 2"	-	3010123				-	-	-	-	-	-	-
3970234**	MB 420/1 CT RSM 30	Rp 2"	◆	-				-	-	-	-	-	-	-
3970221*	MBC 1200/1 - RSM 60	Rp 2"	-	3010367	-	-	-	-	-	-	-			
3970225**	MBC 1200/1 CT RSM 60	Rp 2"	◆	-	-	-	-	-	-	-	-			
3970222*	MBC 1900/1 - FSM 40	DN 65	-	3010367	●	●								
3970226**	MBC 1900/1 CT FSM 40	DN 65	◆	-	●	●								
3970223*	MBC 3100/1 - FSM 40	DN 80	-	3010367	●	●								
3970227**	MBC 3100/1 CT FSM 40	DN 80	◆	-	●	●								

Please see designation of Gas Train Series in the page before the Catalogue index.

* 230V/50Hz - 220V/60Hz electrical supply.

** 230V/50Hz electrical supply.

The valve seal control device is compulsory (conforming to EN 676) on gas trains to burners with a maximum output over 1200 kW.

To select the gas train please refer to the technical data leaflet and/or instruction manual.

C.T. Gas valve leak detection control device:

- gas train not equipped with leak detection control device; this device can be ordered separately - see VPS column - and installed later.

◆ gas train equipped with leak detection control device.

VPS Valve leak detection control device. Supplied separately from the gas train (please see Gas train accessories paragraph for both 50 Hz and 60 Hz codes).

● Not available.

Two Stage Progressive Gas Burners

RS SERIES

Available models

Gas Trains

CODE	GAS TRAIN			VPS CODE	ADAPTER CODE								
	MODEL	∅	C.T.		RS 34	RS 44-50	RS 64	RS 70	RS 100	RS 130	RS 150	RS 190	
3970145*	CB 512/1 - RSM 30	Rp 1" 1/2	-	3010367	-	-							
20045589**	CB 512/1 CT RSM 30	Rp 1" 1/2	◆	-	-	-	3000843						
3970146*	CB 520/1 - RSM 30	Rp 2"	-	3010367	3000822			-	-	-	-	-	-
3970160**	CB 520/1 CT RSM 30	Rp 2"	◆	-				-	-	-	-	-	-
20044659*	CB 525/1 - RSM 30	Rp 2"	-	3010367				-	-	-	-	-	-
20044660**	CB 525/1 CT RSM 30	Rp 2"	◆	-				-	-	-	-	-	-
3970147*	CB 5065/1 - FSM 30	DN 65	-	3010367	●		3000825						
3970161**	CB 5065/1 CT FSM 30	DN 65	◆	-	●								
3970148*	CB 5080/1 - FSM 30	DN 80	-	3010367	●	●	3000826						
3970162**	CB 5080/1 CT FSM 30	DN 80	◆	-	●	●							
3970149*	CB 50100/1 - FSM 30	DN 100	-	3010367	●	●	3010370 + 3000826						
3970163**	CB 50100/1 CT FSM 30	DN 100	◆	-	●	●							
20015871*	CB 50125/1 - FSM 30	DN 125	-	3010367	●	●	●	●	●	3010224 + 3000826			
3970196**	CB 50125/1 CT FSM 30	DN 125	◆	-	●	●	●	●	●				

Please see designation of Gas Train Series in the page before the Catalogue index.

* 230V/50Hz -220V/60Hz electrical supply.

** 230V/50Hz electrical supply.

The valve seal control device is compulsory (conforming to EN 676) on gas trains to burners with a maximum output over 1200 kW.

To select the gas train please refer to the technical data leaflet and/or instruction manual.

C.T. Gas valve leak detection control device:

- gas train not equipped with leak detection control device; this device can be ordered separately - see VPS column - and installed later.

◆ gas train equipped with leak detection control device.

VPS Valve leak detection control device. Supplied separately from the gas train (please see Gas train accessories paragraph for both 50 Hz and 60 Hz codes).

● Not available.

Burner accessories

Extended head kit

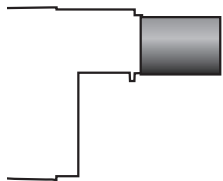

“Standard head” burners can be transformed into “extended head” versions, by using the special kit. The KITS available for the various burners, giving the original and the extended lengths, are listed below.

BURNER	'STANDARD HEAD' LENGTH (mm)	'EXTENDED HEAD' LENGTH (mm)	KIT CODE
▶ RS 34 MZ	216	351	3010428
▶ RS 44 MZ	216	351	3010429
▶ RS 50	216	351	3010078
▶ RS 64 MZ	250	385	3010427
▶ RS 70	250	385	3010117
▶ RS 100	250	385	3010118
▶ RS 130	280	415	3010119
▶ RS 150	280	415	20052186
▶ RS 190	370	520	3010443 *

* Kit to be used on burners recognizable by a serial number that is over or equal to 02426XXXXXX, for burners with a serial number that is under or equal to 02416XXXXX please use the Kit coded 3010196

Spacer kit

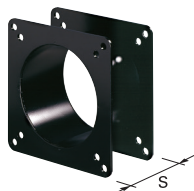

If burner head penetration into the combustion chamber needs reducing, varying thickness spacers are available, as given in the following table:

BURNER	SPACER THICKNESS S (mm)	KIT CODE
▶ RS 34 MZ - 44 MZ - 50	110	3010095
▶ RS 64 MZ - 70 - 100 - 130 - 150	135	3010129
▶ RS 190	102	3000722

Continuous ventilation kit



If the burner requires continuous ventilation in the stages without flame, a special kit is available as given in the following table:

BURNER	KIT CODE
▶ RS 34 MZ - 44 MZ	3010449
▶ RS 50 - 64 - 70 - 100 - 130 - 150 - 190	3010094

Post-ventilation kit



To prolong ventilation after opening of thermostats chain, a special kit is available.

BURNER	POST-VENTILATION TIME (s)	KIT CODE
▶ All models	5	3010004
	20	3010452

Two Stage Progressive Gas Burners

RS SERIES

Burner accessories

Connection flange kit

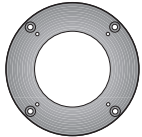

A kit is available for use where the burner opening on the boiler is of excessive diameter.

BURNER	KIT CODE
▶ RS 34 MZ - 44 MZ - 50	3010138

Sound proofing box

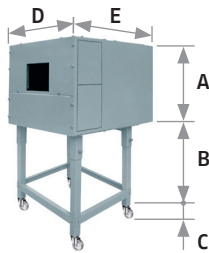

If noise emission needs reducing even further, sound-proofing boxes are available. In case of generator heights, where a lower dimension "B" is required, ask for the Box Support Kit code 20065135. The useful dimensions are 40 mm less than the total dimensions indicated in the table (A, D, E). Not suitable for outdoor use.

BURNER	BOX TYPE	A (mm)	B (mm) min-max	C (mm)	D (mm)	E (mm)	[dB(A)] (*)	BOX CODE
▶ RS 34 MZ - 44 MZ RS 50 - RS 64 MZ	C1/3	650	372 - 980	110	690	770	10	3010403
▶ RS 70 - 100 - 130 - 150 - 190	C4/5	850	160 - 980	110	980	930	10	3010404

(*) Average noise reduction according to EN 15036-1 standard

LPG kit

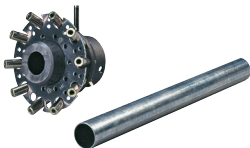

For burning LPG gas, a special kit is available to be fitted to the combustion head on the burner, as given in the following table:

BURNER	KIT CODE FOR 'STANDARD HEAD'	KIT CODE FOR 'EXTENDED HEAD'
▶ RS 34 MZ	3010423	3010423
▶ RS 44 MZ	3010424	3010424
▶ RS 50	20008173	20008173
▶ RS 64 MZ	3010434	3010435
▶ RS 70	20008175	20008176
▶ RS 100	20008177	20008178
▶ RS 130	20008179	20008180
▶ RS 150	20050064	20050065
▶ RS 190	3010166	3010166

Burner accessories

Town gas kit



For burning Town gas, a special kit is available:

BURNER	KIT CODE FOR 'STANDARD HEAD' (*)	KIT CODE FOR 'EXTENDED HEAD' (*)
▶ RS 34 MZ	3010502	3010502
▶ RS 44 MZ	3010503	3010503
▶ RS 50	3010285	3010285
▶ RS 70	3010286	3010286
▶ RS 100	3010287	3010287
▶ RS 130	3010288	3010288
▶ RS 190	3010297	3010297

(*) Without CE certification

Vibration reduction kit



The kit allow you to improve flame stability in some applications, where the boiler/flue assembly is liable to resonate.

BURNER	KIT CODE
▶ RS 50 TC - RS 50 TL	3010200
▶ RS 70 TC - RS 70 TL	3010201
▶ RS 100 TC - RS 100 TL	3010202
▶ RS 130 TC	3010373
▶ RS 130 TL	3010374
▶ RS 190 TC	3010375

Ground fault interrupter kit



A "Ground fault interrupter kit" is available as a safety device for electrical system fault.

BURNER	KIT CODE
▶ RS 34 MZ - 44 MZ	3010448
▶ RS 50 - RS 64 MZ	3010321
▶ RS 70 - 100 - 130 - 150 - 190	3010329

Gas max pressure switch kit

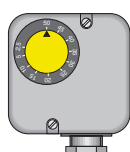

If necessary a Gas max pressure Switch kit is available.

BURNER	KIT CODE
▶ RS 34 MZ - 44 MZ*	3010418
▶ RS 50 - 64 MZ - 70 - 100 - 130 - 150 - 190	3010493

* Connectable to the burner electrical wiring through Plugs & Sockets system

Two Stage Progressive Gas Burners

RS SERIES

Burner accessories

Volt free contact kit

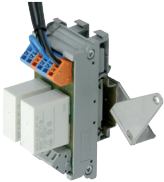

A volt free contact kit is available for installation onto the burner. It can be used for a remote interface between burner operating signals. Every burner can be equipped with a single kit for a remote check of the flame presence signal and the burner lockout indication.

BURNER	KIT CODE
► RS 34 MZ - 44 MZ - 64 MZ	3010419

PC interface kit



To connect the control box to a personal computer for the transmission of operation, fault signals and detailed service information, an interface adapter with PC software are available.

BURNER	KIT CODE
► RS 34 MZ - 44 MZ - 50 - 64 MZ - 70 - 100 - 130 - 150 - 190	3002719

Hours counter kit

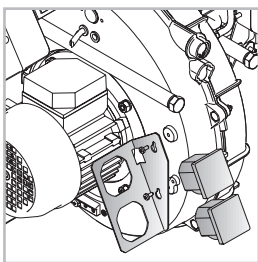

To measure the burner working time a hours counter kit is available.

BURNER	KIT CODE
► RS 34 MZ - 44 MZ	3010450

DN80 gas flange kit

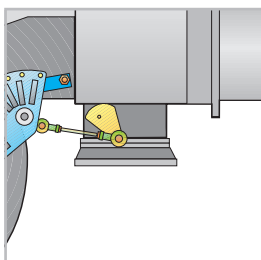

To modify the standard 2" burner gas input connection in to DN80 connection, a specific gas flange is available.

BURNER	KIT CODE
► RS 64 MZ - 70 - 100 - 130 - 150 - 190	3010439

Burner accessories

Protection kit (electromagnetic interferences)

When the burner is installed in a room particularly subject to electromagnetic interference (signals emitted over 10 V/m) due for example to INVERTER presence or in systems where the lengths of the thermostat connections is over 20 meters, this specific protection kit is available as an interface between the thermostatic controls and the burner.

BURNER	KIT CODE
► All models	3010386

Head kit for “reverse flame chamber”



In certain cases, the use of the burner on reverse flame boilers can be improved by using an additional cylinder.









BURNER	STANDARD HEAD LENGTH WITH CYLINDER (mm)	EXTENDED HEAD LENGTH WITH CYLINDER (mm)	KIT CODE (*)
► RS 190	493	-	3010241

(*) EC certification in progress

Gas train accessories

Adapters

In certain cases, an adapter must be fitted between the gas train and the burner, when the diameter of the gas train is different from the set diameter of the burner. Below are given the available adapters; please see on the Gas Train list the correct adapter codes to select.

ADAPTER	LENGTH mm	ADAPTER CODE
2"  1" 1/2	70	3000822
3/4"  1" 1/2	31	3000824
DN 65  2" 1/2  2"	300	3000825
DN 80  2" 1/2  1" 1/2	300	3000826
1" 1/2  2"	35	3000843
1" 1/4  1" 1/2	35	3010124
1" 1/4  2"	35	3010126

Two Stage Progressive Gas Burners

RS SERIES

Gas train accessories

Stabiliser spring



Accessory springs are available to vary the pressure range of the gas train stabilisers. The following table shows these accessories with their application range. Please refer to the technical manual for the correct choice of spring.

GAS TRAIN	SPRING COLOUR	SPRING PRESSURE RANGE mbar	SPRING CODE
▶ MBC 1900/1 – 3100/1 MBC 5000/1	White	4 – 20	3010381
	Red	20 – 40	3010382
	Black	40 – 80	3010383
	Green	80 – 150	3010384
▶ CB 512/1	Red	25 – 55	3010131
	Black	60 – 110	3010157
	Pink	90 – 150	3090486
▶ CB 520/1 – 525/1	Red	25 – 55	3010132
	Black	60 – 110	3010158
	Pink	100 – 150	3090487
▶ CB 5065/1 – 5080/1	Red	25 – 55	3010133
	Black	60 – 110	3010135
	Pink	100 – 150	3090456
	Grey	140 – 200	3090992

Seal control kit



To test the valve seals on the gas train, a special “seal control kit” is available. The valve seal control device is compulsory (EN 676) on gas trains to burners with a maximum output over 1200 kW. The seal control is type VPS 504.

GAS TRAIN	KIT CODE for 50 Hz operation	KIT CODE for 60 Hz operation
▶ MB/1 type	3010123	20050030
▶ MBC/1 type	3010367	20029057
▶ CB/1 type	3010367	20029057